



**The  
best  
Ladders  
for  
professionals**

**Catalogue**

# Household

Pages 4-18





# Ladders for the household

Maximum  
permitted load **120** kg  
per step

**5** year  
warranty

## BS-DAeco 120 series

Single-sided platform step ladders. Stable platform and wide aluminium steps with anti-slip structure guarantee users' safety. Additional protection is ensured by plastic rungs and a guardrail to facilitate climbing. Each step can withstand the pressure of 120 kg.



The  
best  
**Ladders**  
for  
professionals

# Single-sided household platform step ladders BS-DAeco 120 type



Strong  
anti-slip  
platform



Stable,  
anti-slip  
aluminium rungs



Anti-slip feet



**BS-DA5eco 120**

**BS-DA3eco 120**



**BS-DA4eco 120**





## Single-sided household platform step ladders BS-DAeco 120 type

**BS-DA6eco 120**



**BS-DA7eco 120**



**BS-DA8eco 120**

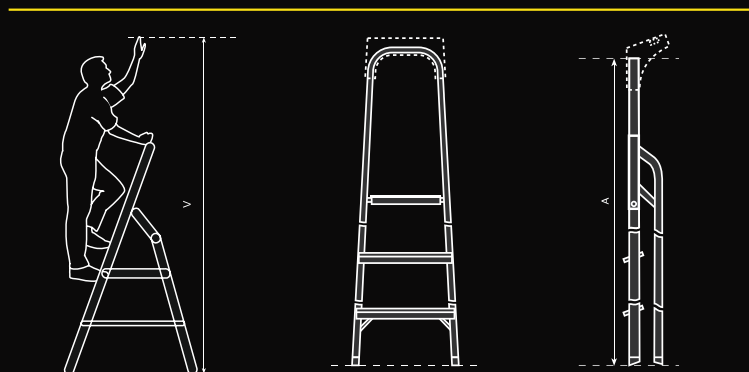

TYPE	BS-DA3eco 120	BS-DA4eco 120	BS-DA5eco 120	BS-DA6eco 120	BS-DA7eco 120	BS-DA8eco 120
Number of steps	3	4	5	6	7	8
Height of the folded ladder mm A	1253	1483	1713	1943	2173	2403
Working height mm V	2565	2780	2995	3210	3425	3640
Weight in kg	2,8	3,4	3,9	4,2	5	6,1



# Household

Maximum permitted load **150** kg per step

**5** year warranty

NORM  
PN EN-131

## BS-DAeco series

Single-sided aluminium platform step ladders in compliance with European norm PN EN-131. Stable platform and wide aluminium steps with anti-slip structure to ensure safety. Additional protection is given by plastic rungs and a guardrail to facilitate climbing. Each step can withstand the pressure of 150 kg.



The  
best  
**Ladders**  
for  
professionals



# Single-sided household platform step ladders BS-DAeco type

**BS-DA2eco**



**Strong anti-slip platform**



**Stable, anti-slip aluminium rungs**



**Anti-slip feet**



**BS-DA5eco**

**BS-DA3eco**



**BS-DA4eco**



## Single-sided household platform step ladders BS-DAeco type

### BS-DA6eco



### BS-DA7eco



### BS-DA8eco

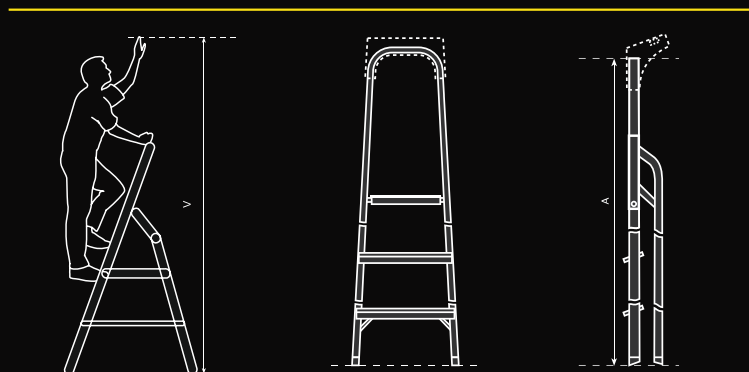

	2	3	4	5	6	7	8
Number of steps	2	3	4	5	6	7	8
Height of the folded ladder mm A	1119	1253	1483	1713	1943	2173	2403
Working height mm V	2440	2565	2780	2995	3210	3425	3640
Weight in kg	2,8	3,1	3,6	4,1	5,1	5,6	6,2







# Household

Maximum permitted load **150** kg per step

**5** year warranty

NORM PN EN-131

## BS-DA series

Single-sided aluminium platform step ladders in compliance with European norm PN EN-131.

Stable platform and wide aluminium steps with anti-slip structure to ensure safety.

Additional protection is given by plastic rungs and a guardrail to facilitate climbing. The guardrail is topped with a plastic platform shelf for tools or brushes, and a hook for a bucket.

Each step can withstand the pressure of 150 kg.



The best  
**Ladders**  
for  
professionals

# Single-sided household aluminium platform step ladders BS-DA type

**BS-DA3**



**Handy shelf**



**Stable anti-slip platform**



**Anti-slip feet**



**BS-DA6**

**BS-DA4**



**BS-DA5**



## Single-sided household aluminium platform step ladders BS-DA type

**BS-DA7**



**BS-DA8**

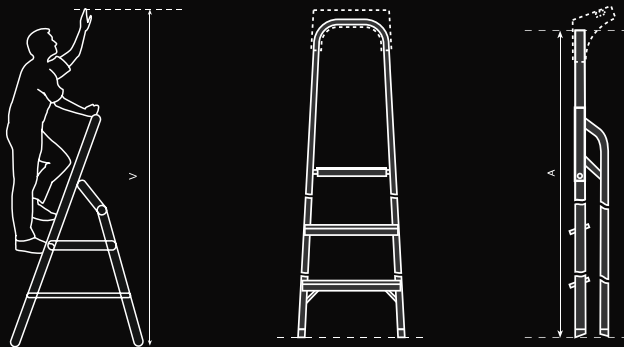

	3	4	5	6	7	8
Number of steps	3	4	5	6	7	8
Height of the folded ladder mm A	1272	1502	1732	1962	2192	2422
Working height mm V	2560	2775	2995	3205	3420	3635
Weight in kg	3,35	3,9	4,5	5,55	6,15	6,8





**BAYERSYSTEM**

# Household

Maximum permitted load **150** kg per step

**5** year warranty

NORM PN EN-131

## BS-DDA series

Aluminium twin step ladders with comfortable, wide, anti-slip steps and topped with a stable platform. Compliant with European norm, each step withstands 150 kg.

Safety is ensured by spreader tapes /against collapse/ and plastic anti-slip rungs.



The best  
**Ladders**  
for  
professionals

# Household aluminium twin step ladders BS-DDA type

**BS-DDA2**

Comfortable  
anti-slip  
platform



Safety  
spreader  
tapes

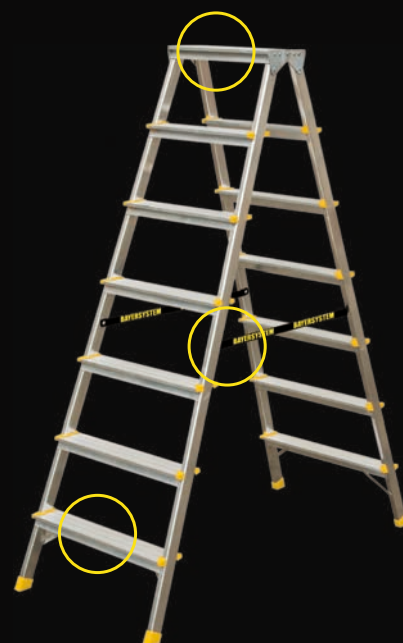

Stable anti-slip  
aluminium rungs

**BS-DDA3****BS-DDA4****BS-DDA5**



## Household aluminium twin step ladders BS-DDA type

### BS-DDA6



### BS-DDA7

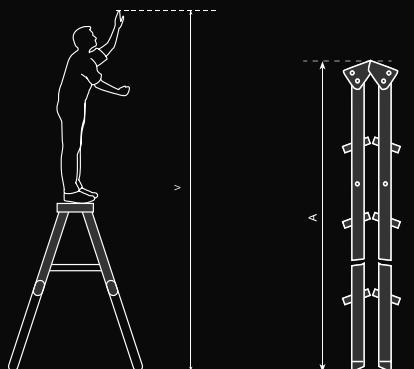

TYPE	BS-DDA2	BS-DDA3	BS-DDA4	BS-DDA5	BS-DDA6	BS-DDA7
Number of steps	2x2	2x3	2x4	2x5	2x6	2x7
Height of the folded ladder mm A	490	720	950	1180	1410	1640
Working height mm V	2433	2649	2865	3081	3297	3513
Weight in kg	2,1	2,9	3,8	4,7	5,6	6,6

# Combination

Pages 20-38



# Combination

Maximum permitted load **150** kg per step

**5** year warranty

NORM  
PN EN-131

## BS-DJ 1x

Industrial extension ladder made of aluminium, compliant with European norm PN EN-131. Light and easy to move and transport. Ideal for renovation and construction works. Praised by gardening enthusiasts.



The  
best  
**Ladders**  
for  
professionals



# Combination freestanding step ladders BS-DJ 1x type

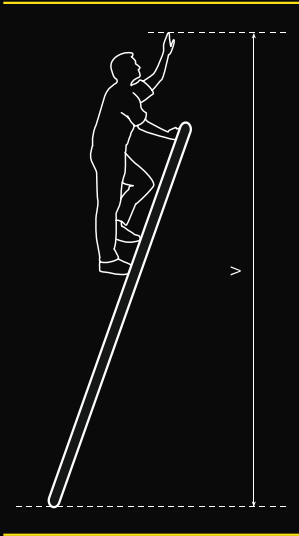

**BS-DJ 1x7**



**BS-DJ 1x8**



**BS-DJ 1x9**



**BS-DJ 1x10**



**BS-DJ 1x11**



**BS-DJ 1x12**



**BS-DJ 1x13**



**BS-DJ 1x14**



**BS-DJ 1x15**

Number of steps	7	8	9	10	11	12	13	14	15
Working height mm V	2979	3223	3467	3711	3955	4199	4443	4687	4931
Weight in kg	2,9	3,2	3,6	4	4,4	4,8	5,2	5,6	6,6

# Combination

Maximum permitted load **150** kg per step

**5** year warranty

NORM PN EN-131

## BS-DW 2x

Aluminium ladder compliant with European norm PN EN-131.

Certified load capacity of 150 kg per step.

A twin step ladder to be unfolded and leaned against a wall of a building. Safety is ensured by anti-slip steps, a wide stabiliser attached to the foot of the ladder, anti-slip feet and extension bar preventing unwanted collapse.



The best  
**Ladders**  
for  
professionals

# Combination freestanding step ladders BS-DW 2x type

**BS-DW2x7**



**Automatic ladder lock**



**Stabilising bar**

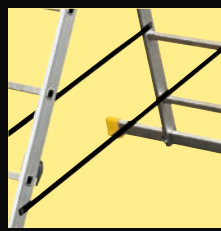

**Spreader rope or bar preventing collapse**

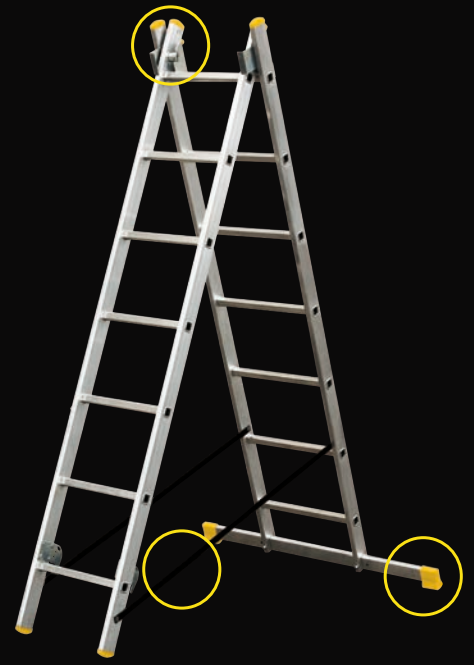

**BS-DW2x10**

**BS-DW2x8**



**BS-DW2x9**





# Combination freestanding step ladders BS-DW 2x type

## BS-DW2x11



## BS-DW2x12



## BS-DW2x13

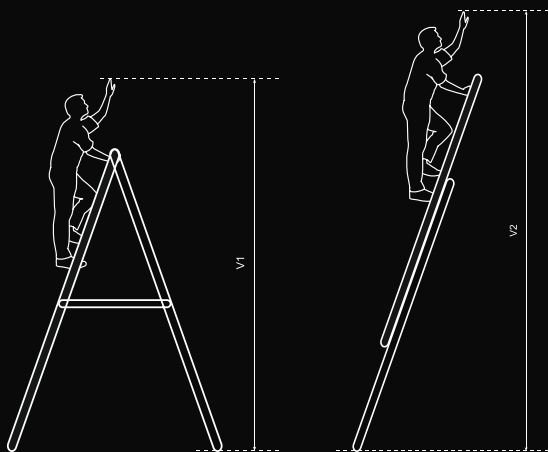

TYPE	BS-DW 2x7	BS-DW 2x8	BS-DW 2x9	BS-DW 2x10	BS-DW 2x11	BS-DW 2x12	BS-DW 2x13	BS-DW 2x14	BS-DW 2x15
Number of steps	2x7	2x8	2x9	2x10	2x11	2x12	2x13	2x14	2x15
Working height mm V1	2982	3226	3470	3714	3958	4202	4446	4690	4934
Working height mm V2	3973	4461	4949	5437	5925	6169	6657	7145	7633
Weight in kg	8	9	10	11	14,4	15,3	16,5	17,4	20

# Combination freestanding step ladders BS-DW 2x type

**BS-DW2x14****BS-DW2x15**

# Combination

Maximum permitted load **150** kg per step

**5** year warranty

NORM PN EN-131

## BS-DW 3x

Aluminium ladder compliant with European PN EN-131 norm with a certified load capacity of 150 kg per step.

A twin step ladder to be unfolded and leaned against a wall of a building.

Possibility of conversion into a freestanding ladder. Hooks prevent the ladder from collapsing. Safety is ensured by anti-slip steps, a wide stabiliser attached to the foot of the ladder, anti-slip feet and extension bar or tape (depending on the number of steps) preventing collapse.

The best  
**Ladders**  
for  
professionals





# Combination freestanding step ladders BS-DW 3x type

**BS-DW3x7**



**Automatic lock**



**Safety hook to ensure the ladder does not fold back**



**Strong tape or bar preventing collapse**



**BS-DW3x10**

**BS-DW3x8**



**BS-DW3x9**



# Combination freestanding step ladders BS-DW 3x type

**BS-DW3x11**



**BS-DW3x12**



**BS-DW3x13**

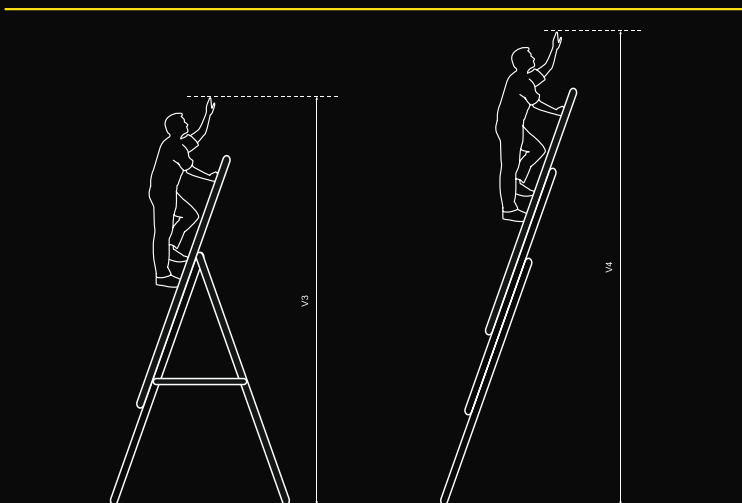

	3x7	3x8	3x9	3x10	3x11	3x12	3x13	3x14	3x15
Number of steps	3x7	3x8	3x9	3x10	3x11	3x12	3x13	3x14	3x15
Working height mm V3	3472	3960	4448	4936	5179	5667	6155	6927	7443
Working height mm V4	4966	5698	6186	6918	7406	8138	8880	9625	10357
Weight in kg	10,8	12,5	14	18,4	22,1	23,8	28	34	36

# Combination freestanding step ladders BS-DW 3x type

**BS-DW3x14**



**BS-DW3x15**





# Combination

Maximum permitted load **150** kg per step

**5** year warranty

NORM  
PN EN-131

## BS-DR 2x7

Universal, multi-purpose aluminium scaffolding compliant with European PN EN-131 norm. Possibility of conversion into a freestanding step ladder or extension ladder.

Ideal for renovation or gardening works. One product – many possibilities.



The  
best  
**Ladders**  
for  
professionals

# Ladder-scaffolding BS-DR 2x7



Wide working platform



Casters to wheel the scaffolding around



## BS-DR 2x7

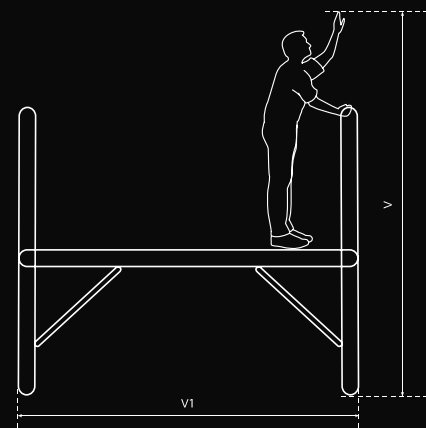

TYPE	BS-DR 2x7
Number of steps	2x7
Working height mm V	2839
Working height mm V1	1200
Weight in kg	12,9

# Combination

Maximum permitted load **150** kg per step

**5** year warranty

NORM PN EN-131

## BS-DR xS

Aluminium ladders BS-DR xS type are compliant with the European norm PN EN-131; maximum permitted load per step – 150 kg. Very stable, guardrails to facilitate climbing, a wide platform for comfortable work are definitely the features valued in workshops, warehouses and production plants. Casters ensure the possibility to wheel the ladder around.



The best  
**Ladders**  
for  
professionals



# Ladder-scaffolding BS-DR xS

**BS-DR5S**



Handrails  
for greater  
user comfort



Bar protecting  
against collapse



Casters to wheel  
the scaffolding

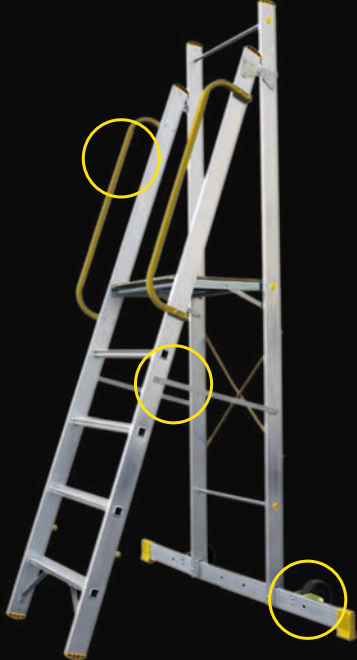

**BS-DR6S**



**BS-DR7S**

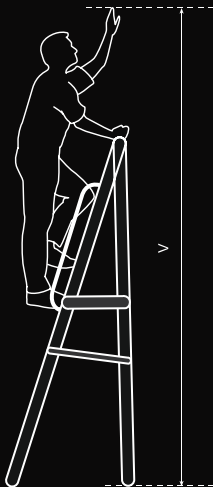

# Ladder-scaffolding BS-DR xS

**BS-DR8S****BS-DR9S**

	5	6	7	8	9
Number of steps	5	6	7	8	9
Working height mm V	3194	3439	3683	3927	4172
Weight in kg	13,7	15,35	17	18,65	20,3





# Combination

Maximum permitted load **150** kg per step

**5** year warranty

NORM PN EN-131

## BS-DR 4x3

Aluminium ladder compliant with European norm PN EN-131 with a certified load capacity of 150 kg per step.

A twin step to be unfolded and leaned against a wall of a building. Its construction allows it to be unfolded or placed anywhere, depending on the user's needs. Safety is ensured by two stabilisers with plastic feet and three pairs of heavy-duty hinges, preventing collapse.

The best  
**Ladders**  
for  
professionals



# Ladder-scaffolding BS-DR 4x3

**Automatic lock****Anti-slip feet**

## BS-DR 4x3

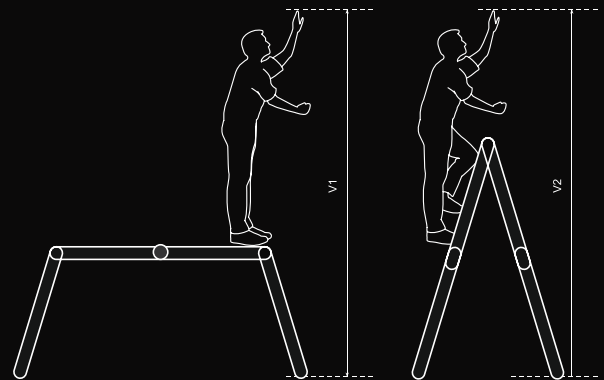

TYPE	BS-DR4x3
Number of steps	4x3
Working height mm V2	3188
Working height mm V1	2871
Weight in kg	12,95

Whether you are constructing, renovating, DIY-ing or working at heights, Bayersystem Grzenia Sp.j. will take care of your safety. You will find all the necessary equipment here – a wide selection of aluminium household and combination ladders, which you may select for different jobs or works at heights. The ladders we offer are compliant with the European PN EN-131 norm and are covered with a 5-year guarantee. The quality of the products delivered is crucial for us – our products have successfully met stringent norms and testing. As we are the market leaders, our products facilitate work and make it safer than ever before. Our satisfied clients range from well-known construction market brands located in the Republic of Poland and beyond.

Our philosophy is to see our clients admit with pride that BAYERSYSTEM is a trustworthy partner.

This fact may also be backed up by various awards the company has so far received: Przedsiębiorstwo Fair Play (Fair Play Enterprise), Laureat Rankingu Firm Rodzinnych (Winner of Family Business Ranking), Certyfikat Firmy Sprzyjającej Środowisku (Certified Green Company), Certyfikat Wiarygodności Biznesowej (Certificate of Business Credibility), Gazeta Biznesu (Business Gazette).

We shall be honoured if you also join the circles of our satisfied clients.



**Publisher: Bayersystem Grzenia Sp.j.**

Any reproduction and use of this catalogue in whole or in part without permission is prohibited. This publication is intended to familiarize you with our products. It does not constitute an offer under the Civil Code. We are not responsible for the colour discrepancies that may occur between this publication, and the actual colours of the products. At the same time, we reserve the right to make changes in the prices, colours and designs of the presented goods.

The name and trademark BAYERSYSTEM is restricted by BAYERSYSTEM Grzenia Sp.j.

Warranty service throughout the country.



**BAYERSYSTEM**<sup>®</sup>

LADDER • LEITER • ÉCHELLE • DRABINA

**Bayersystem Grzenia Sp. j.**

85-433 Bydgoszcz

ul. Św. M. Kolbego 48

tel. +48 52 320 77 77

fax +48 52 320 77 88

biuro@bayersystem.com

www.bayersystem.com

